

1. Description

➤ Advantages

BLG3040 is obtained by advanced ignition IGBTs technology which reduce the conduction loss, enhance the SCIS capability. Internally integrated diodes can provide the voltage clamping without the need for external components. The IGBT is suitable device for automotive ignition circuits, specifically as a coil driver.

➤ Key Characteristics

Parameter	Value	Unit
$V_{CES,Typ}$	425	V
$V_{CE(sat),Typ}$	1.25	V
$E_{SCIS}@T_J=25\text{ }^\circ\text{C}$	300	mJ
ESD	4	kV

➤ Features

- Low V_{CEsat}
- High SCIS Energy
- Logic Level Gate Drive

➤ Applications

- Ignition Coil Driver Circuits
- Coil-On Plug Application

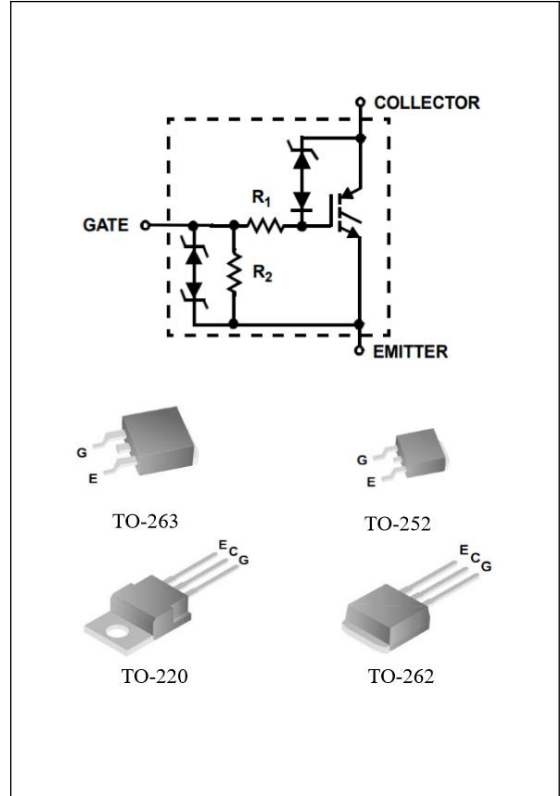

➤ Ordering Informations

Ordering Codes	Package	Product Code	Packing
BLG3040-D	TO-252	G3040	Tape Reel
BLG3040-P	TO-220		Tube
BLG3040-I	TO-262		Tube
BLG3040-B	TO-263		Tape Reel

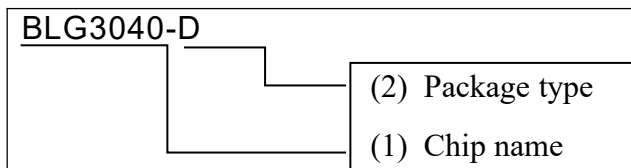
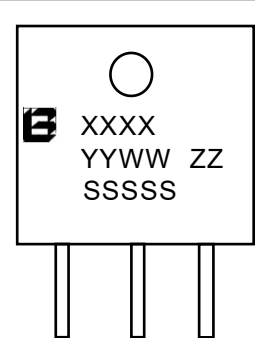
<p>BLG3040-D</p>  <p>(1) BLG3040:425V 300mJ (2) D:TO-252 P: TO-220 I:TO-262 B: TO-263</p>	 <p>XXXX: Product Code YYWW: Year & Week ZZ: Assembly Code SSSSS: Lot Code</p>
---	---

2. Absolute Ratings

at $T_C = 25^\circ\text{C}$, unless otherwise specified

Symbol	Parameter	Rating	Units
V_{CES}	Collector-Emitter Voltage ($I_C=2\text{mA}$, $R_G=1\text{k}\Omega$)	455	V
V_{ECS}	Emitter to Collector Voltage ($I_C=10\text{mA}$)	24	V
E_{SCIS}	SCIS Energy@ $T_J=25^\circ\text{C}$, $I_{SCIS}=14.2\text{A}$, $L=3\text{mH}$, $R_G=1\text{k}\Omega$	300	mJ
	SCIS Energy@ $T_J=150^\circ\text{C}$, $I_{SCIS}=10.6\text{A}$, $L=3\text{mH}$, $R_G=1\text{k}\Omega$	170	mJ
I_C	Collector Current @ $T_C=25^\circ\text{C}$	21	A
	Collector Current @ $T_C=100^\circ\text{C}$	17	A
ESD	Electrostatic Discharge Voltage (HBM) at 100pF, 1500Ω	4	kV
V_{GEM}	Gate- Emitter Voltage Continuous	± 10	V
P_D	Power Dissipation @ $T_C = 25^\circ\text{C}$	150	W
T_J, T_{stg}	Operating Junction and Storage Temperature Range	175, -40 to 175	$^\circ\text{C}$
T_L	Maximum Temperature for Soldering	260	$^\circ\text{C}$

3. Thermal Characteristics

Symbol	Parameter	Package	RATINGS	Units
$R_{\theta JC}$	Junction-to-Case	TO-252/TO-220/TO-262/TO-263	1.0	$^\circ\text{C} / \text{W}$

4. Electrical Characteristics

at $T_C = 25^\circ\text{C}$, unless otherwise specified

OFF Characteristics						
Symbol	Parameter	Test Conditions	Values			Units
			Min.	Typ.	Max.	
BV_{CER}	Collector to Emitter Breakdown Voltage	$V_{GE}=0\text{V}$, $I_C=2\text{mA}$, $R_G=1\text{k}\Omega$	395	425	455	V
BV_{CES}	Collector to Emitter Breakdown Voltage	$V_{GE}=0\text{V}$, $I_C=10\text{mA}$, $R_G=0\Omega$	410	440	470	V
BV_{ECS}	Emitter to Collector Breakdown Voltage	$V_{GE}=0\text{V}$, $I_C=-75\text{mA}$	30	--	--	V
BV_{GES}	Gate to Emitter Breakdown Voltage	$I_{GES}=\pm 2\text{mA}$	± 12	± 14		V
I_{CER}	Collector to Emitter Leakage Current	$V_{CE}=250\text{V}$, $R_G=1\text{k}\Omega$, $T_J=25^\circ\text{C}$	--	--	25	μA
		$V_{CE}=250\text{V}$, $R_G=1\text{k}\Omega$, $T_J=150^\circ\text{C}$	--	--	1	mA
I_{ECS}	Emitter to Collector Leakage Current	$V_{EC}=24\text{V}$, $T_J=25^\circ\text{C}$	--	--	1	mA
		$V_{EC}=24\text{V}$, $T_J=150^\circ\text{C}$			40	mA

R ₁	Series Gate Resistance		--	70		Ω
R ₂	Gate to Emitter Resistance		10		26	kΩ

ON Characteristics

Symbol	Parameter	Test Conditions	Values			Units
			Min.	Typ.	Max.	
V _{CE(sat)}	Collector-Emitter Saturation Voltage	V _{GE} =4V, I _C =6A, T _J =25°C	--	1.20	1.60	V
V _{CE(sat)}	Collector-Emitter Saturation Voltage	V _{GE} =4.5V, I _C =10A, T _J =175°C	--	1.52	1.80	V
V _{CE(sat)}	Collector-Emitter Saturation Voltage	V _{GE} =4.5V, I _C =15A, T _J =175°C	--	1.90	2.20	V
V _{GE(TH)}	Gate Threshold Voltage	V _{CE} = V _{GE} , I _C = 1mA	1.30	--	2.20	V

Pulse width $t_p \leq 300\mu s$, $\delta \leq 2\%$

Dynamic Characteristics

Symbol	Parameter	Test Conditions	Values			Units
			Min.	Typ.	Max.	
C _{iss}	Input Capacitance	V _{GE} = 0V V _{CE} = 25V f=1.0MHz	--	1250	--	pF
C _{oss}	Output Capacitance		--	69	--	
C _{rss}	Reverse Transfer Capacitance		--	15	--	
Q _g	Total Gate Charge	I _C =10A, V _{CE} =12V, V _{GE} =5V	--	7.2	--	nC

Switching Characteristics

Symbol	Parameter	Test Conditions	Values			Units
			Min.	Typ.	Max.	
t _{d(ON)}	Turn-on Delay Time	V _{CE} = 14V, R _L =1Ω, V _{GE} = 5V, R _G =1kΩ, T _J =25°C	--	0.85	4	μs
t _r	Rise Time		--	2.50	7	
t _{d(OFF)}	Turn-Off Delay Time	V _{CE} = 300V, L=500μH, V _{GE} = 5V, R _G =1kΩ, T _J =25°C	--	4.40	15	
t _f	Fall Time		--	1.90	15	

5. Characteristics Curves

Figure 1 Collector-Emitter Saturation Voltage vs Junction Temperature

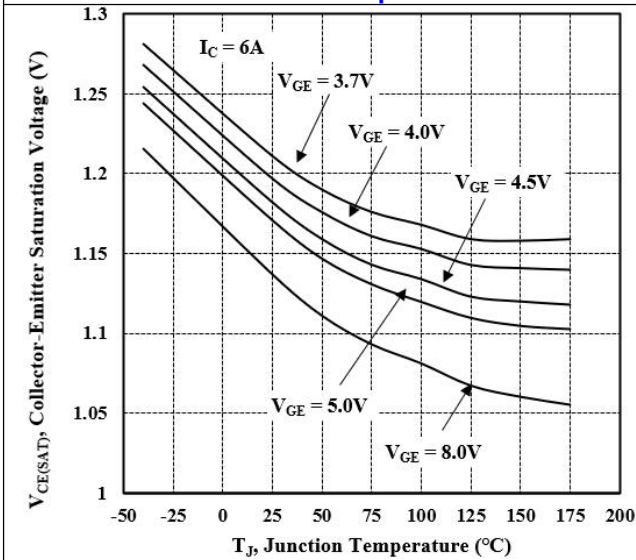

Figure 2 Collector-Emitter Saturation Voltage vs Junction Temperature

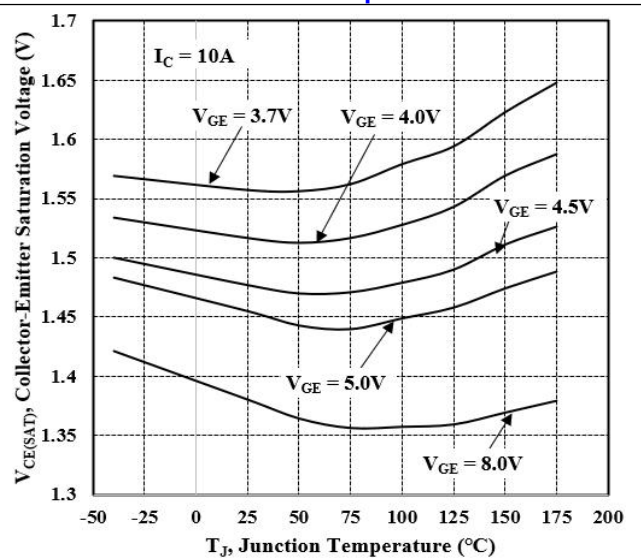

Figure 3 Self Clamped Inductive Switching Current vs Inductance

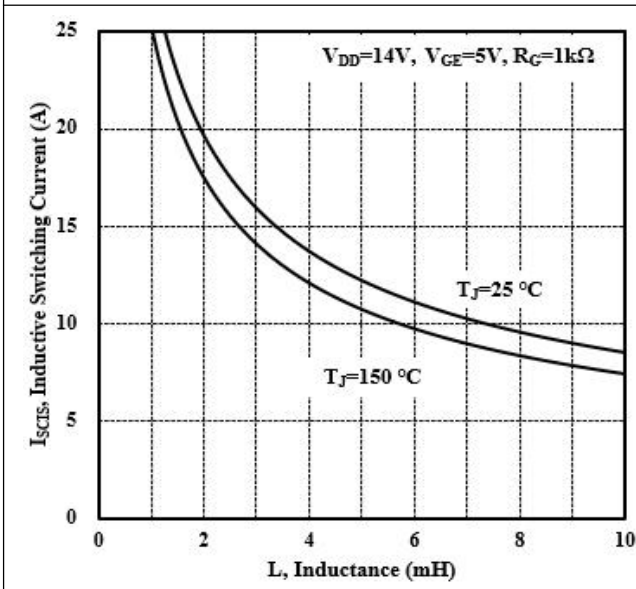

Figure 4 Self Clamped Inductive Switching Current vs Inductance

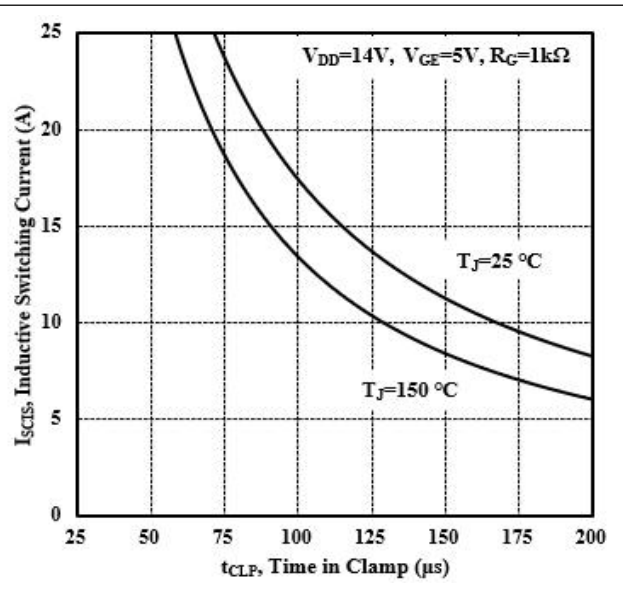

Figure 5 Power Dissipation vs Case Temperature

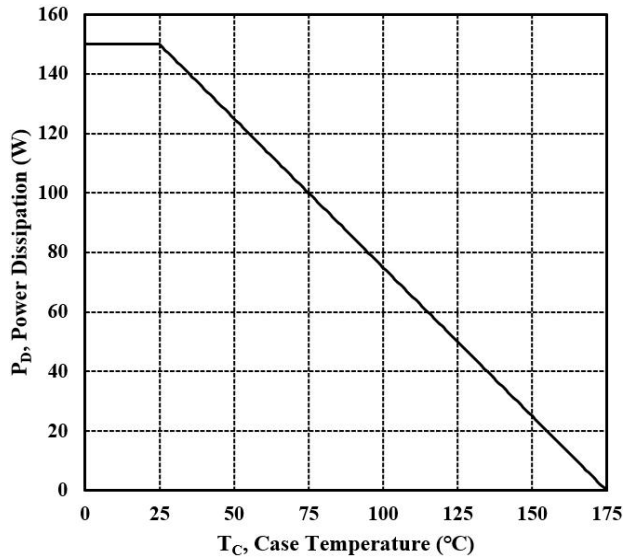

Figure 6. DC Collector Current vs Case Temperature

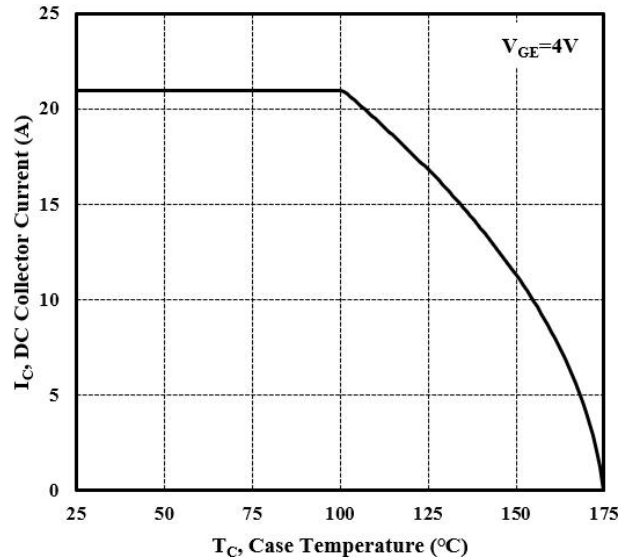

Figure 7 Threshold Voltage vs Junction Temperature

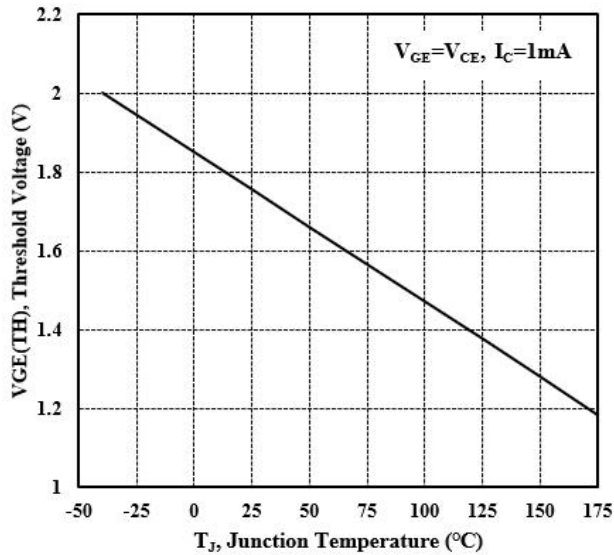

Figure 8 Breakdown Voltage vs Series Gate Resistance

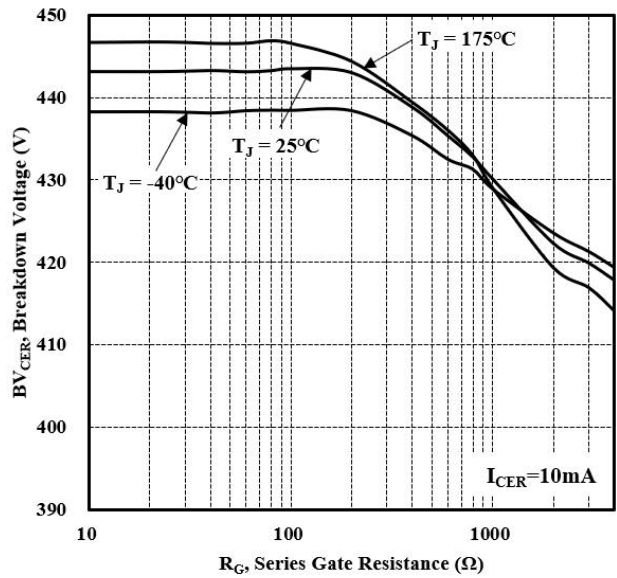

Figure 9 Leakage Current vs Junction Temperature

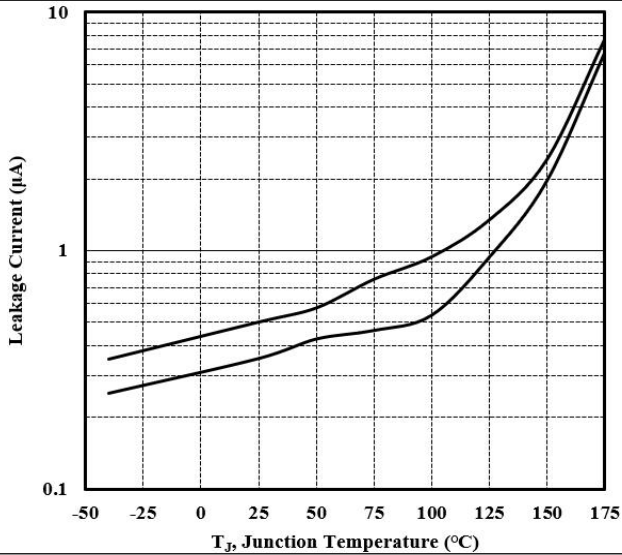

Figure 10 Collector-Emitter Voltage vs Collector Current

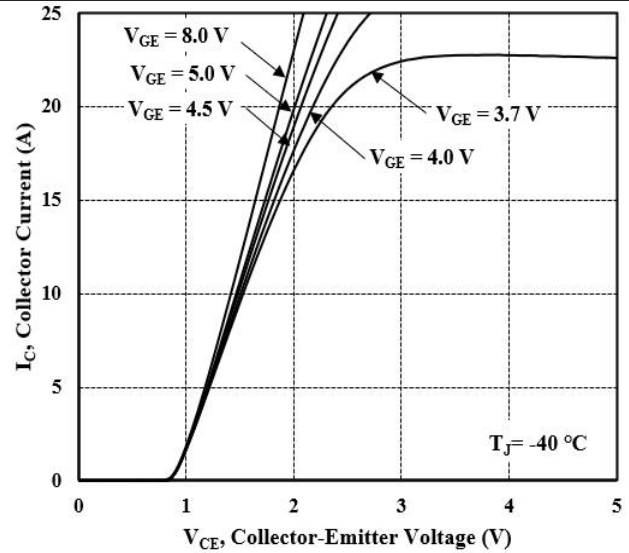

Figure 11 Collector-Emitter Voltage vs Collector Current

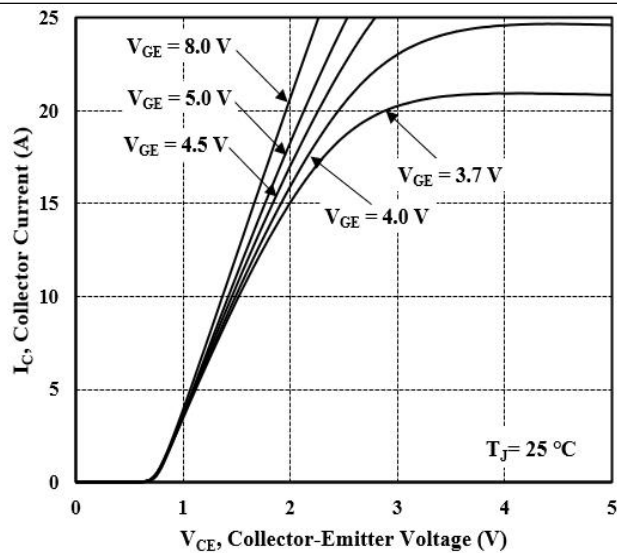

Figure 12 Collector-Emitter Voltage vs Collector Current

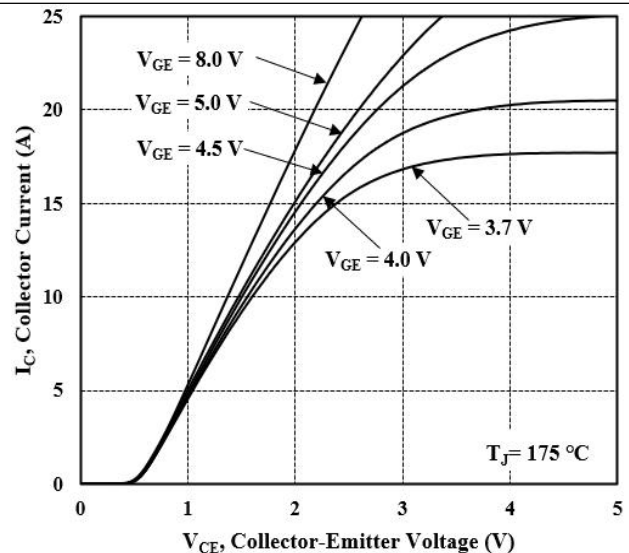

Figure 13 Transfer Characteristics

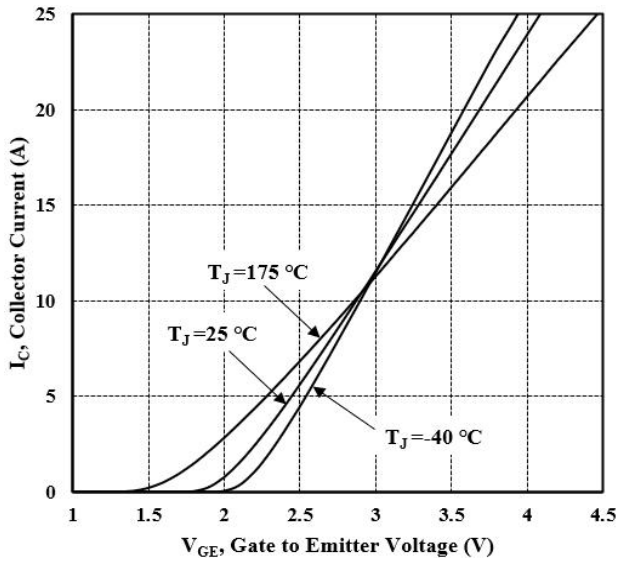

Figure 14 Capacitance vs Collector to Emitter Voltage

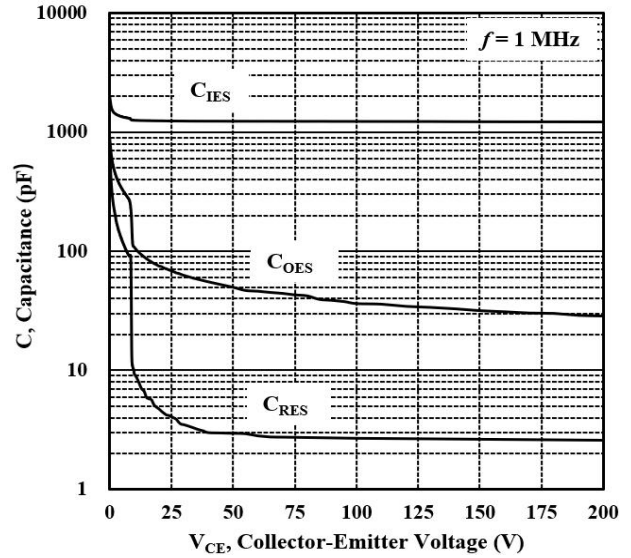

Figure 15 Gate Charge vs Gate to Emitter Voltage

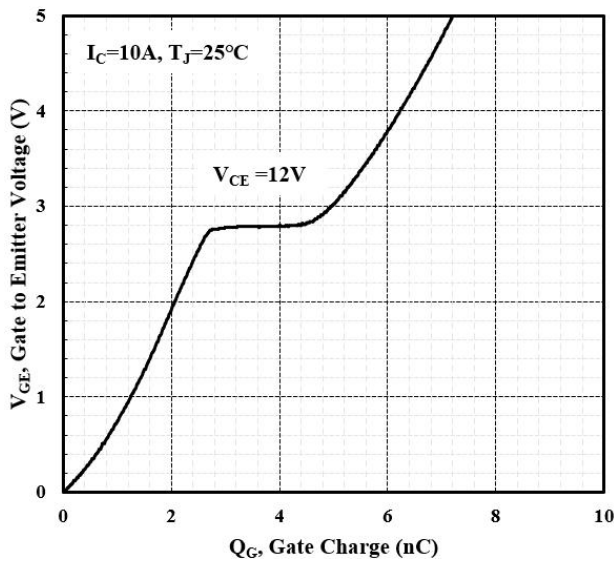

Figure 16 Switching Time vs Junction Temperature

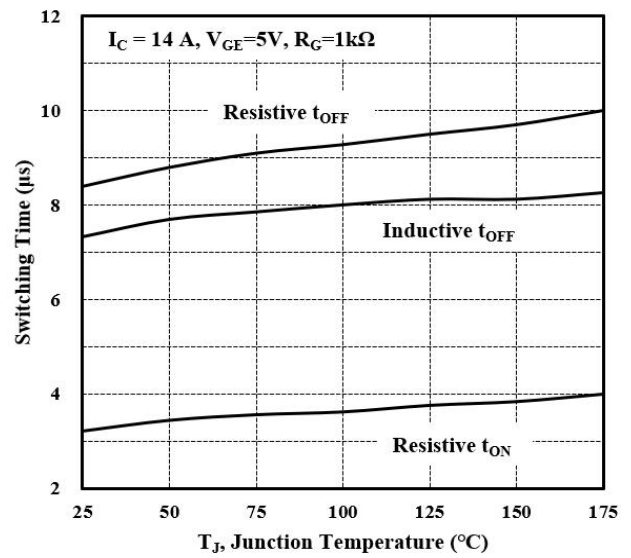
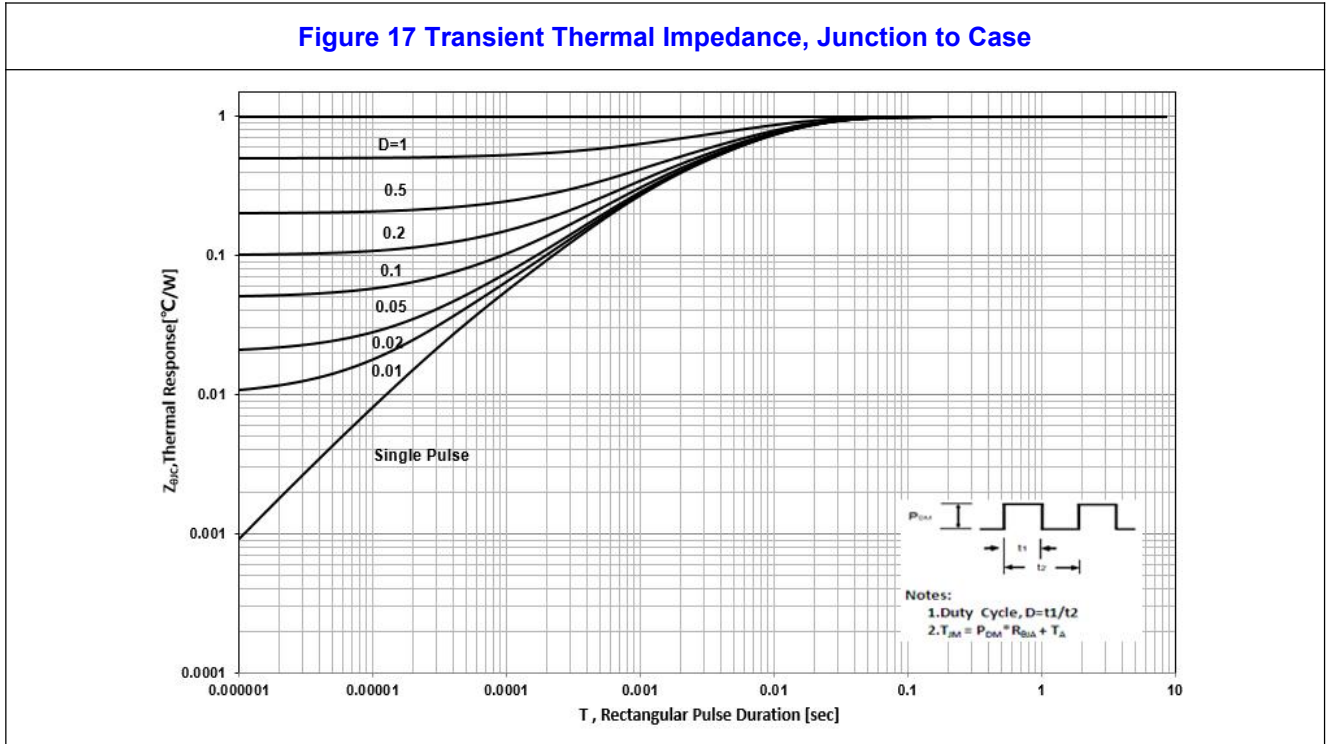

Figure 17 Transient Thermal Impedance, Junction to Case



6. Test Circuit and Waveform

Figure 18 Inductive Switching Test Circuit

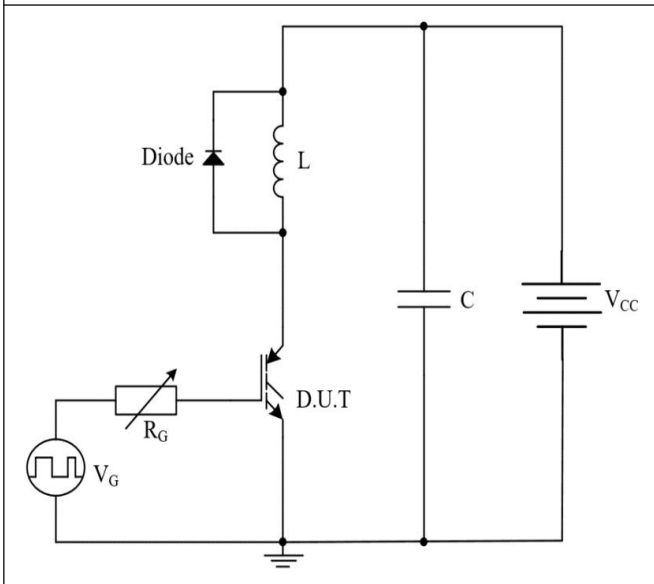

Figure 19 Resistive Switching Test Circuit

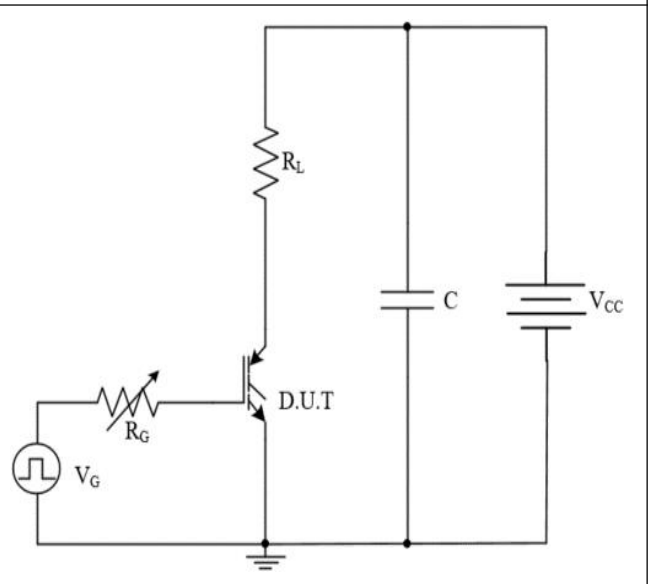

Figure 20 Switching Waveforms

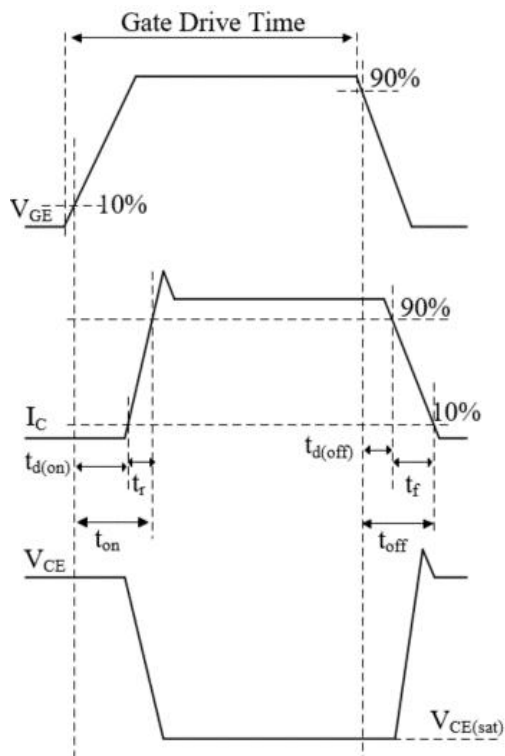

Figure 21 Self Clamped Inductive Switching Circuit

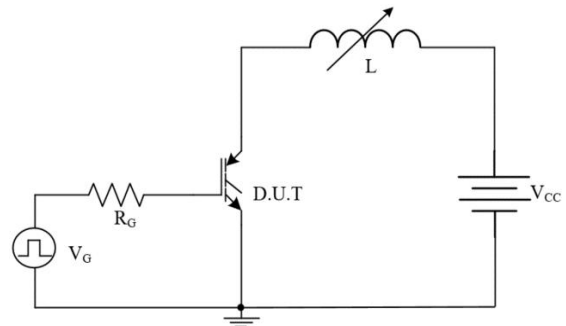
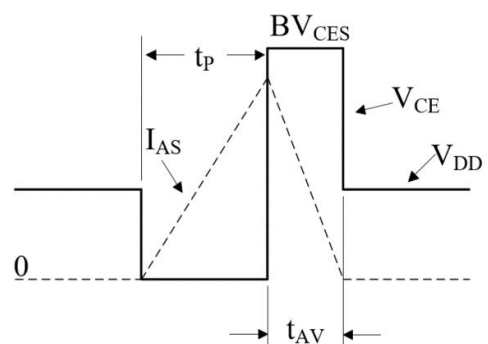
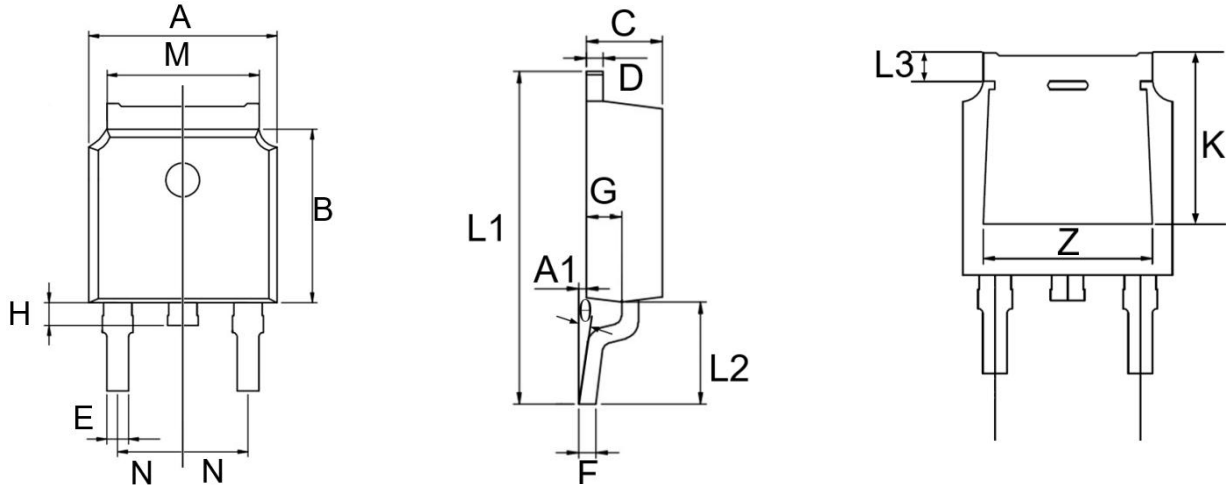

Figure 22 Self Clamped Inductive Switching Waveform



7. Package Description



TO-252 Package

Items	Values(mm)		
	MIN	NOM	MAX
A	6.45	6.60	6.75
A1	0.05	0.10	0.20
B	5.95	6.10	6.25
C	2.15	2.30	2.45
D	0.40	0.50	0.60
E	0.66	0.76	0.86
F	0.40	0.500	0.6
G	0.91	1.07	1.22
H	0.60	0.80	1.00
K	3.80		
L1	9.80	10.10	10.40
L2	2.80	3.10	3.40
L3	0.70	0.80	1.00
H	0.60	0.80	1.00
M	5.12	5.32	5.52
2N	4.57		
Z	4.80		
θ	0°	-	8°

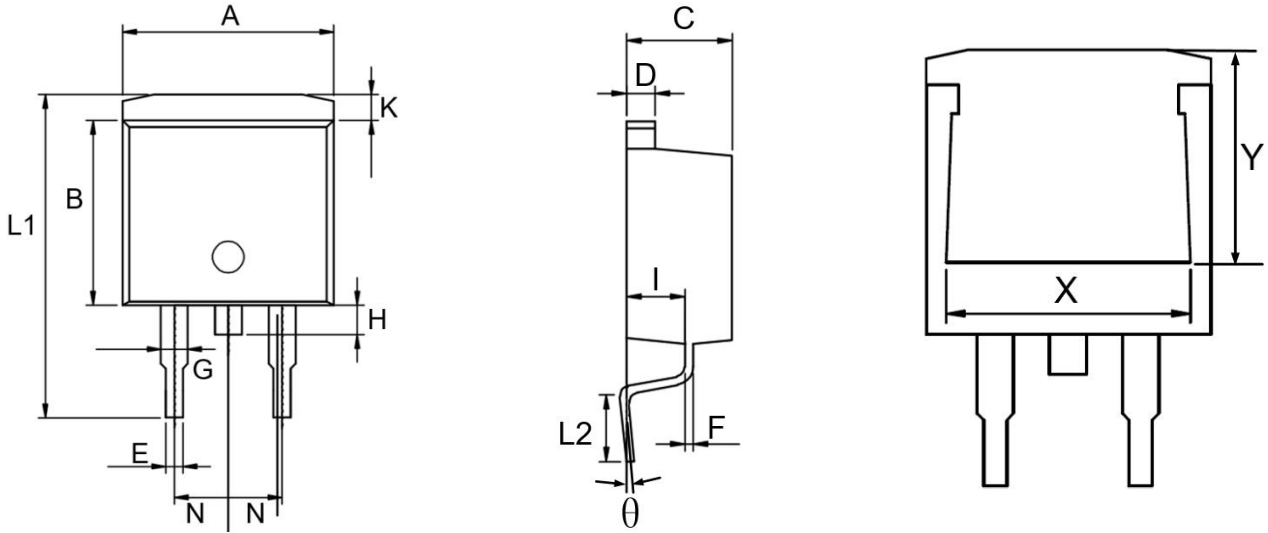

TO-263 Package

Items	Values (mm)		
	MIN	NOM	MAX
A	9.85	10.15	10.45
B	8.46	8.66	8.86
C	4.50	4.70	4.90
D	1.17	1.27	1.37
E	0.72	0.82	0.92
F	0.28	0.38	0.48
G	1.12	1.27	1.42
H	1.20	1.40	1.60
I	2.45	2.60	2.70
K	1.01	1.23	1.50
L1	14.75	15.15	15.55
L2	2.30	2.55	2.80
2N		5.08	
X	7.90	8.10	8.40
Y	5.50	5.70	5.90
θ	0°	7°	8°

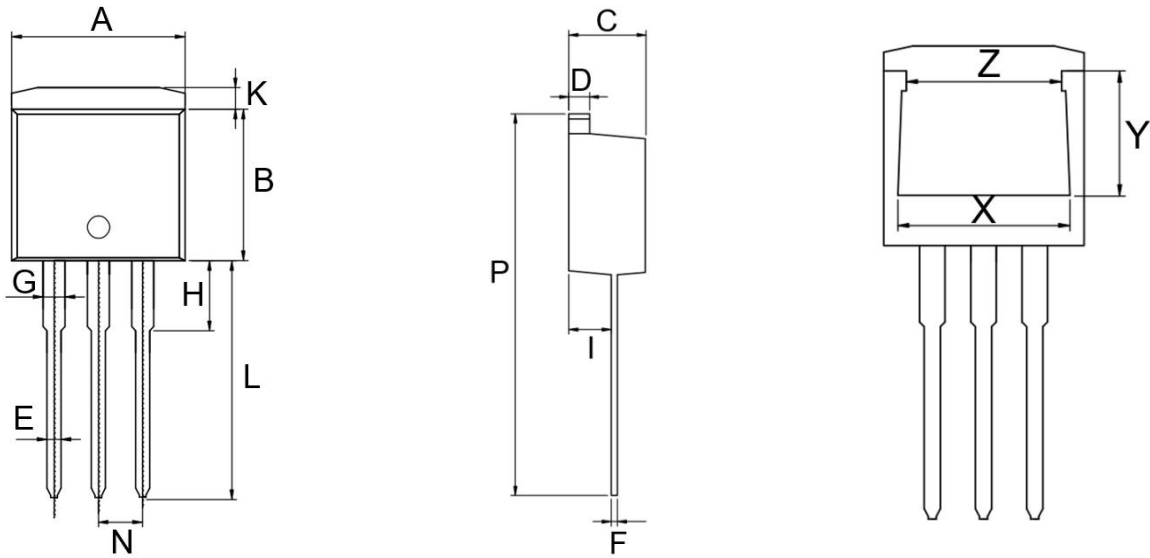

TO-262 Package

Items	Values (mm)		
	MIN	NOM	MAX
A	9.85	10.15	10.45
B	8.46	8.66	8.86
C	4.50	4.70	4.90
D	1.17	1.27	1.37
E	0.72	0.82	0.92
F	0.28	0.38	0.48
G	1.12	1.27	1.42
H	3.85	4.05	4.35
I	2.45	2.60	2.70
K	1.01	1.23	1.50
L	13.10	13.60	14.10
N	-	2.54	-
P	23.20	23.60	24.00
X	7.90	8.10	8.40
Y	5.50	5.70	5.90
Z	7.10	7.30	7.50

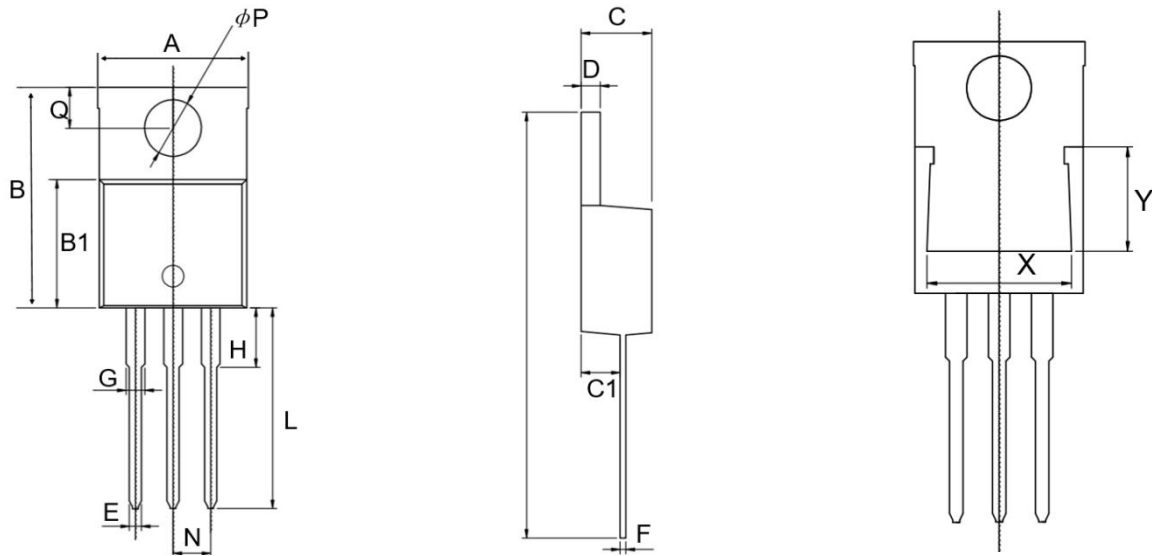

TO-220 Package

Items	Values (mm)		
	MIN	NOM	MAX
A	9.70	10.00	10.30
B	15.10	15.60	16.10
B1	8.80	9.10	9.40
C	4.37	4.57	4.70
C1	2.20	2.40	2.60
D	1.25	1.30	1.40
E	0.70	0.80	0.95
F	0.45	0.50	0.60
G	1.17	1.27	1.47
H	-	3.10	3.40
L	12.75	13.50	13.80
N	2.54		
Q	2.60	2.80	3.00
ΦP	3.40	3.60	3.80
X	7.00	-	-
Y	5.50	-	-

Revision History:

BLG3040 Revision: 2024-01-31, Rev. 2.1-I

Previous Revision

Revision	Date	Revision Date Subjects (major changes since last revision)
1.0	2019-10-21	-
1.1	2021-07-06	Some key Information has been added below. (1) Switching characteristics. (2) Self-clamped Inductive switching current curves. (3) Breakdown voltage curves have been added.
2.0	2022-03-31	The major changes are as follow. (1) In Section 4, the data of ON characteristics and dynamic characteristics have been updated. (2) In Section 5, P_D vs T_J curve and I_{SCIS} vs T_{CLP} curve have been added. (3) In Section 5, all figures of characteristics curves have been reformatted and adjusted in sequence. (4) In Section 6, all figures of test circuit and typical waveform have been redrawn and rearranged. (5) In Section 7, all diagrams of different package and some dimensions information have been redrawn and updated. (6) Formatting and spelling errors in this document have been corrected. (7) Revision history is firstly added in the BLG3040 datasheet .
2.1	2024-01-31	The major changes are as follow. (1) In Section 4, the data of OFF characteristics has been updated. (2) the CONTACT has been updated. (3) The catalog index has been updated.
2.2	2024-07-11	The major changes are as follow. (1) Corrected the value of V_{CES} on the homepage and marked 'Typ.' (2) Updated the testing conditions and values for V_{CES} in '2. Absolute Ratings' on page 2.
2.3	2024-10-23	The major changes are as follow. (1) Additional description of ESCIS: using 3mH inductor and 1K Ω Rg. (2) Additional description of Operating Junction.

We Listen to Your Comments

If there is any information within this document that you feel is wrong, unclear, or missing at all, please contact us.

Your feedback will help us to continuously improve the quality of this document.

Published by
 Shanghai Belling Co., Ltd.
 810, Yishan Road, Shanghai, China
 © 2011 Belling
 All Rights Reserved.

NOTE:

1. Any use beyond the maximum ratings of the device in performance may cause damage to the device or even the permanent failure, which may affect the dependability of the machine. Please do not exceed the absolute maximum ratings of the device when designing circuit.
2. When installing the heat sink, please pay attention to the torsional moment and the smoothness of the heat sink.
3. Semiconductor device is sensitive to the ESD, it is necessary to protect the device from being damaged by the ESD when using it.
4. Shanghai Belling reserves the right to make changes in this specification sheet and is subject to change without prior notice.

CONTACT:

上海贝岭股份有限公司

地址：上海市宜山路 810 号

邮编：200233

联系方式：<https://www.belling.com.cn/contact.html>