

1. Description

BLP02N06L, the N-channel Enhanced Power MOSFETs, is obtained by advanced **double trench** technology which reduce the conduction loss, improve switching performance and enhance the avalanche energy. This is suitable device for Synchronous rectification and high speed switching applications.

KEY CHARACTERISTICS

Parameter	Value	Unit
V _{DSS}	60	V
I _D	60	A
R _{DS(on)} @10V.typ	2.2	mΩ
R _{DS(on)} @4.5V.typ	2.7	mΩ

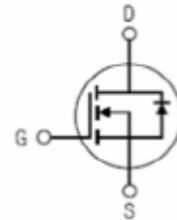
FEATURES

- Fast Switching
- Low On-Resistance
- Low Gate Charge
- Low Reverse transfer capacitances
- High avalanche ruggedness
- RoHS product

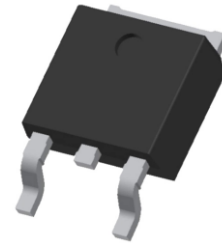
APPLICATIONS

- Synchronous rectification
- High speed switching applications

Inner Equivalent Principium Chart

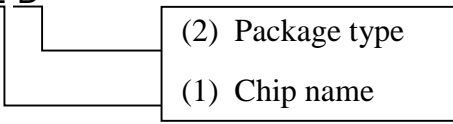



TO-252



ORDERING INFORMATION

Ordering Codes	Product Code	Package	Device Marking	Packing
BLP02N06L-D	BLP02N06L	TO-252	P02N06L	Reel

<p>BLP02N06L-D</p>  <p>(2) Package type (1) Chip name</p> <p>(1) BLP02N06L 2.2mΩ/60V (2) D: TO-252</p>	 <p>XXXX: Device Marking YYWW: Year&Week ZZ: Assembly Code SSSS: Lot Code</p>
---	---

2. ABSOLUTE RATINGS

at $T_C=25^{\circ}\text{C}$, unless otherwise specified

Symbol	Parameter	Rating	Units
V_{DSS}	Drain-Source Voltage	60	V
I_D	Continuous Drain Current, Silicon Limited	203	A
	Continuous Drain Current, Package Limited	60	A
	Continuous Drain Current @ $T_C=100^{\circ}\text{C}$, Silicon Limited	128.5	A
I_{DM} ^{Note1}	Pulsed Drain Current	240	A
V_{GS}	Gate-Source Voltage	± 20	V
E_{AS} ^{Note2}	Avalanche Energy	506	mJ
P_D	Power Dissipation	156.2	W
	Derating Factor above 25°C	1.25	W/ $^{\circ}\text{C}$
T_J, T_{stg}	Operating Junction and Storage Temperature Range	150, -55 to 150	$^{\circ}\text{C}$
T_L	Maximum Temperature for Soldering	260	$^{\circ}\text{C}$

Note1: Repetitive Rating: Pulse width limited by maximum junction temperature

Note2: $L=0.5\text{mH}$, $I_{as}=45\text{A}$, Start $T_J=25^{\circ}\text{C}$

3. Thermal characteristics

Symbol	Parameter	Max	Units
$R_{\theta JC}$	thermal resistance, Junction-Case	0.8	$^{\circ}\text{C}/\text{W}$
$R_{\theta JA}$	thermal resistance, Junction-Ambient	75	$^{\circ}\text{C}/\text{W}$

4. Electrical Characteristics

at $T_C=25^{\circ}\text{C}$, unless otherwise specified

OFF Characteristics						
Symbol	Parameter	Test Conditions	Values			Units
			Min	Typ	Max	
V_{DSS}	Drain-Source Breakdown Voltage	$V_{GS}=0\text{V}$, $I_D=250\mu\text{A}$	60	68	--	V
I_{DSS}	Drain-Source Leakage Current	$V_{DS}=60\text{V}$, $V_{GS}=0\text{V}$	--	--	1	μA
		$V_{DS}=48\text{V}$, $V_{GS}=0\text{V}$ @ $T_C=125^{\circ}\text{C}$	--	--	100	μA
$I_{GSS(F)}$	Gate-Source Forward Leakage	$V_{GS}=+20\text{V}$	--	--	100	nA
$I_{GSS(R)}$	Gate-Source Reverse Leakage	$V_{GS}=-20\text{V}$	--	--	-100	nA

ON Characteristics

Symbol	Parameter	Test Conditions	Values			Unit S
			Min	Typ	Max	
$R_{DS(on)}$	Drain-Source On-Resistance	$V_{GS}=10V, I_D=50A$	--	2.2	2.5	$m\Omega$
		$V_{GS}=4.5V, I_D=30A$	--	2.7	3.6	$m\Omega$
$V_{GS(th)}$	Gate Threshold Voltage	$V_{DS}=V_{GS}, I_D=250\mu A$	1	1.8	2.5	V

Pulse width $t_p \leq 300\mu s$, $\delta \leq 2\%$

Dynamic Characteristics

Symbol	Parameter	Test Conditions	Values			Units
			Min	Typ	Max	
C_{iss}	Input Capacitance	$V_{DS}=30V,$ $V_{GS}=0,$ $f=1MHz$	--	4887	--	pF
C_{oss}	Output Capacitance		--	1542	--	
C_{rss}	Reverse Transfer Capacitance		--	65.6	--	
Q_g	Total Gate Charge	$V_{DD}=30V,$ $I_D=50A,$ $V_{GS}=10V$	--	84	--	nC
Q_{gs}	Gate-Source charge		--	17	--	
Q_{gd}	Gate-Drain charge		--	12.5	--	

Switching Characteristics

Symbol	Parameter	Test Conditions	Values			Units
			Min	Typ	Max	
$t_{d(on)}$	Turn-On Delay Time	$V_{DD}=30V,$ $I_D=50A,$ $V_{GS}=10V,$ $R_G=3\Omega,$ Resistive Load	--	25	--	ns
t_r	Rise Time		--	21	--	
$t_{d(off)}$	Turn-Off Delay Time		--	60	--	
t_f	Fall Time		--	15	--	

Source-Drain Diode Characteristics

Symbol	Parameter	Test Conditions	Values			Units
			Min	Typ	Max	
I_S	Continuous Source Current		--	--	60	A
I_{SM}	Maximum Pulsed Current		--	--	240	A
V_{SD}	Diode Forward Voltage	$V_{GS}=0V, I_S=50A$	--	--	1.2	V
T_{rr}	Reverse Recovery Time	$I_S=50A, V_{GS}=0,$ $di/dt=100A/us$	--	70	--	ns
Q_{rr}	Reverse Recovery Charge		--	115	--	nC

5. Characteristics Curves

Figure 1. Safe Operating Area

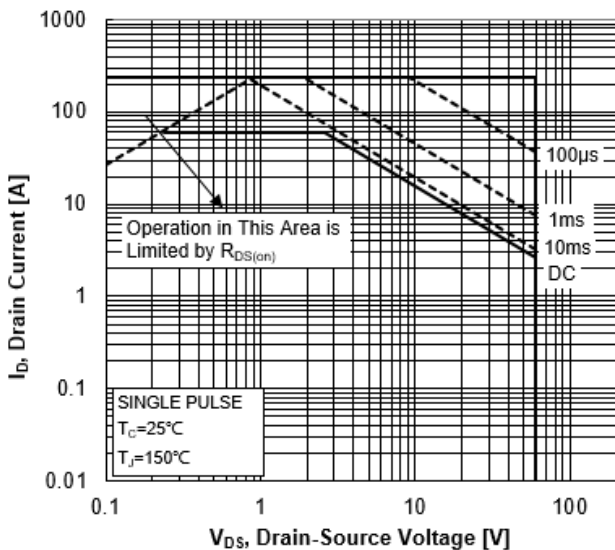


Figure 2. Maximum Power Dissipation vs Case Temperature

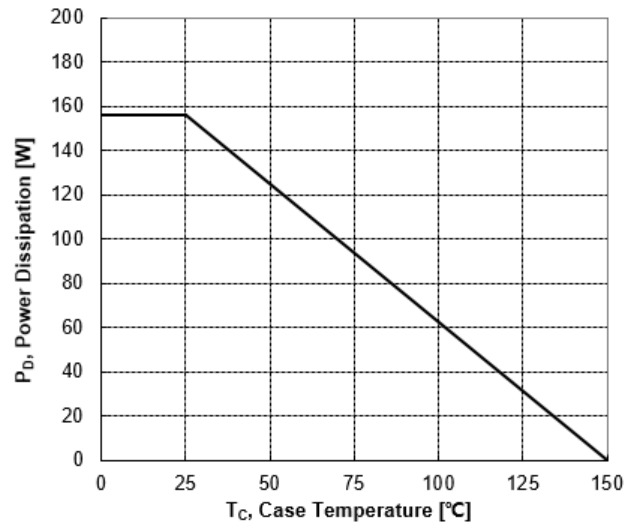


Figure 3. Maximum Continuous Drain Current vs Case Temperature

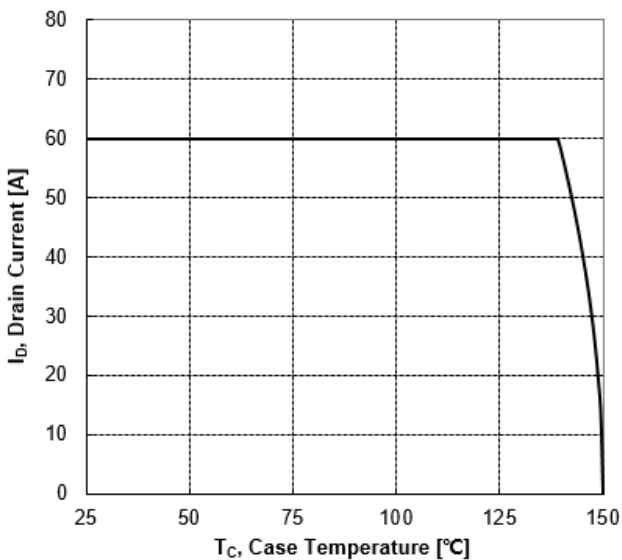


Figure 4. Typical Output Characteristics

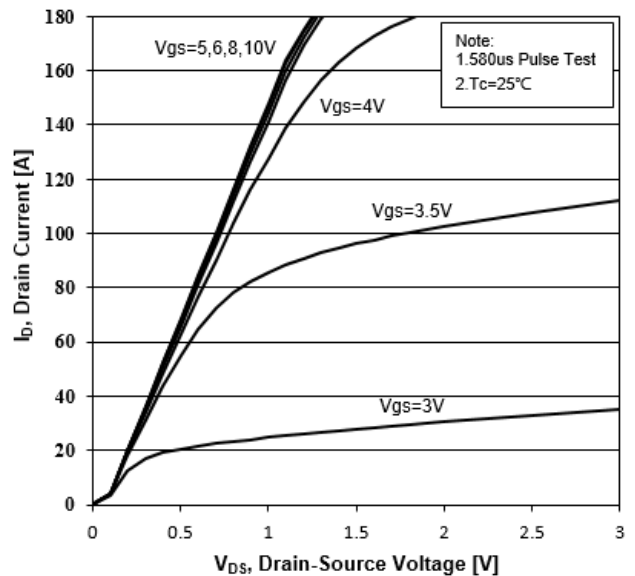


Figure 5. Transient Thermal Impedance

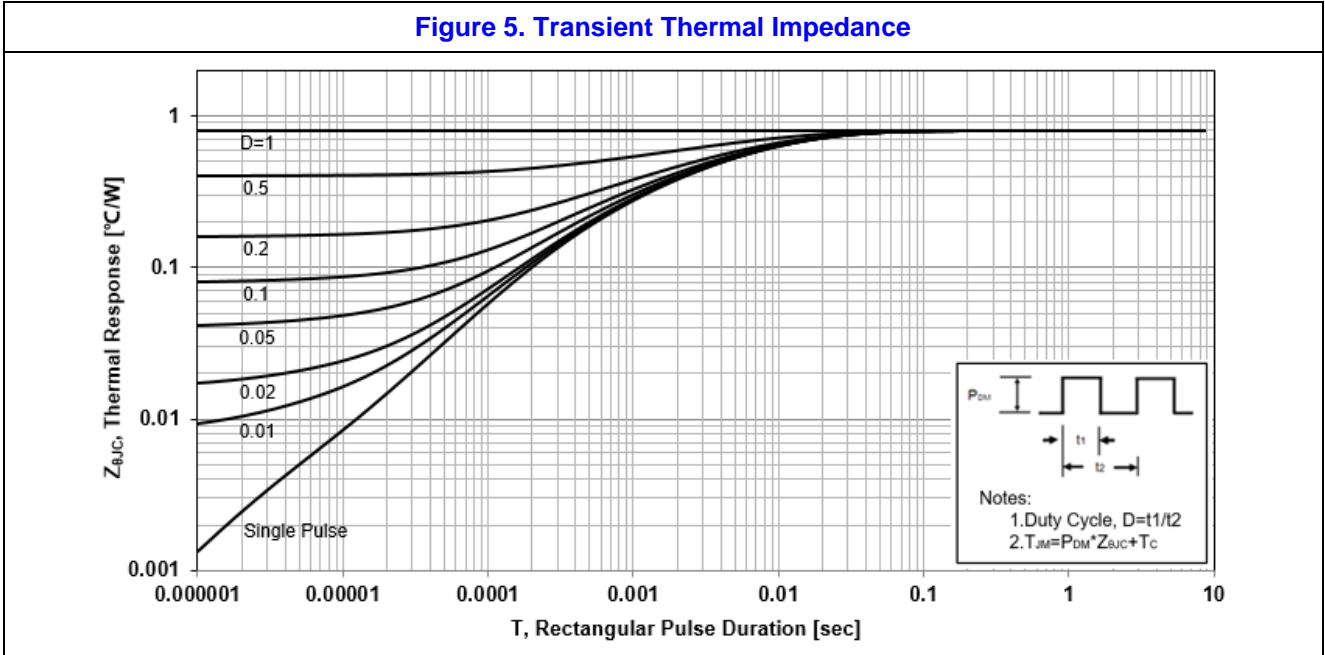


Figure 6. Typical Transfer Characteristics

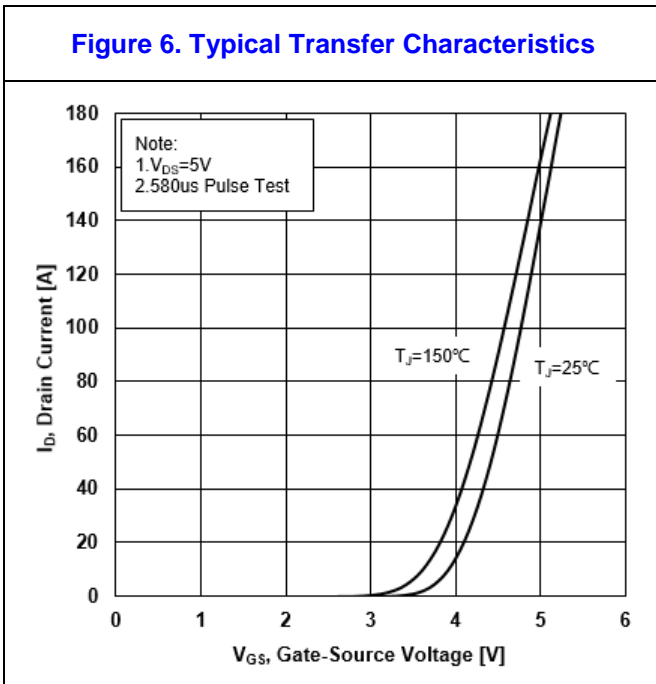


Figure 7. Source-Drain Diode Forward Characteristics

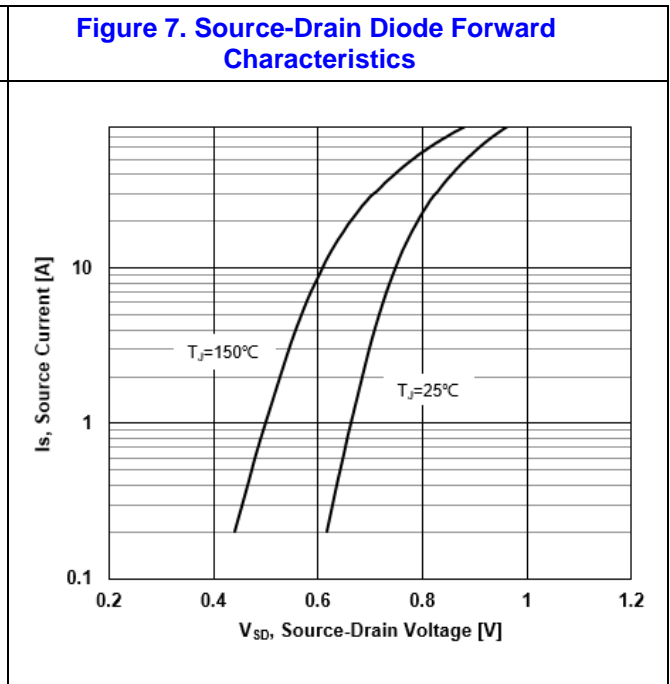


Figure 8. Drain-Source On-Resistance vs Drain Current

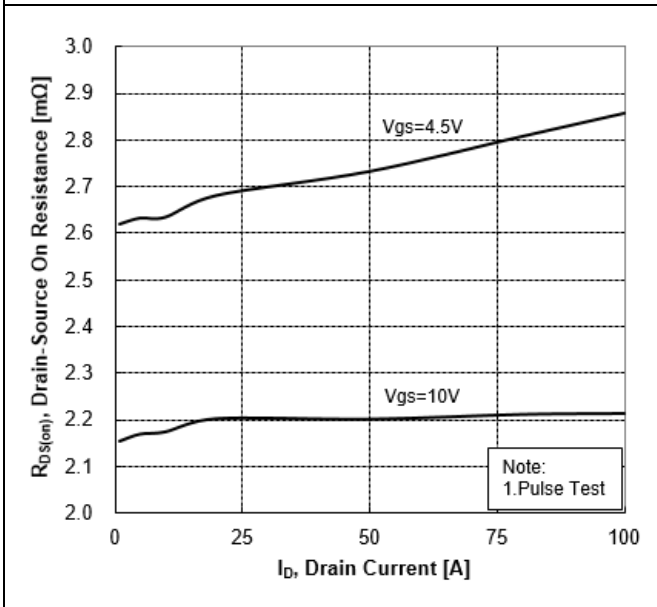


Figure 9. Normalized On-Resistance vs Junction Temperature

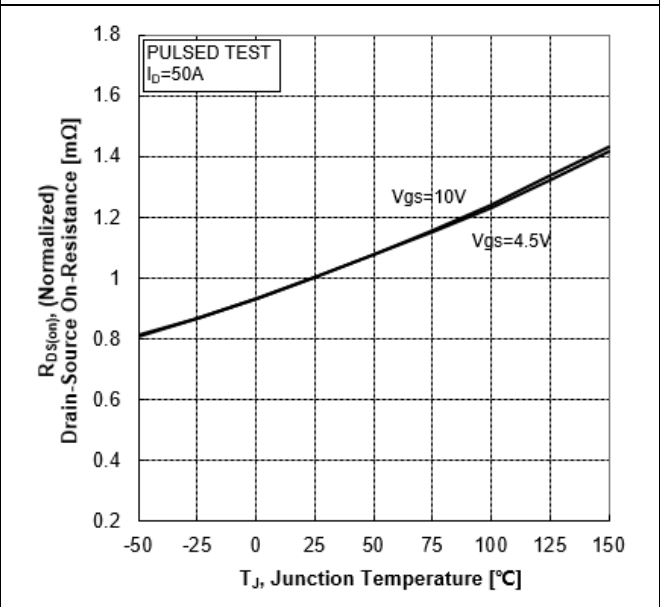


Figure 10. Normalized Threshold Voltage vs Junction Temperature

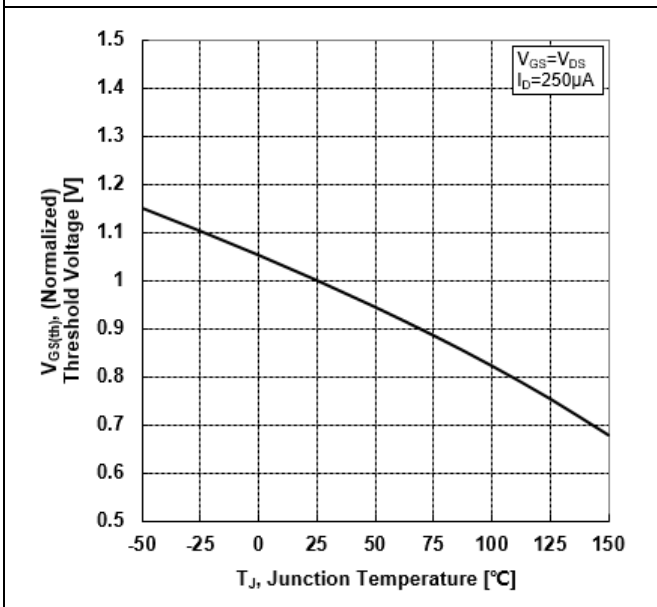


Figure 11. Normalized Breakdown Voltage vs Junction Temperature

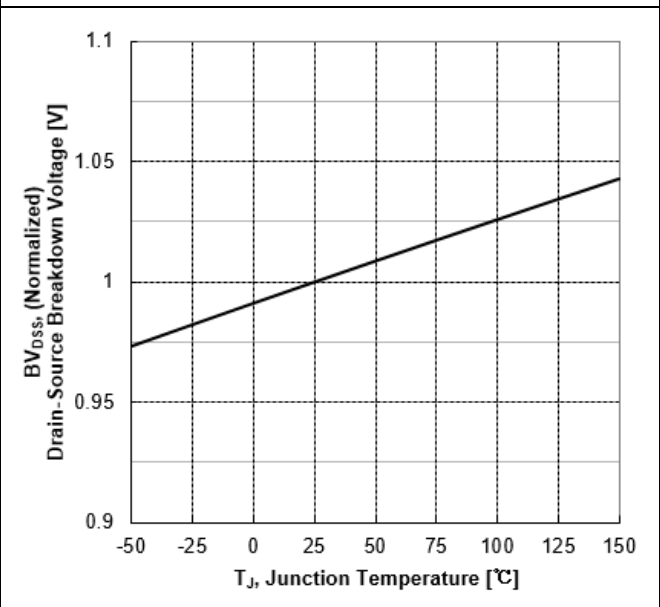


Figure 12. Capacitance Characteristics

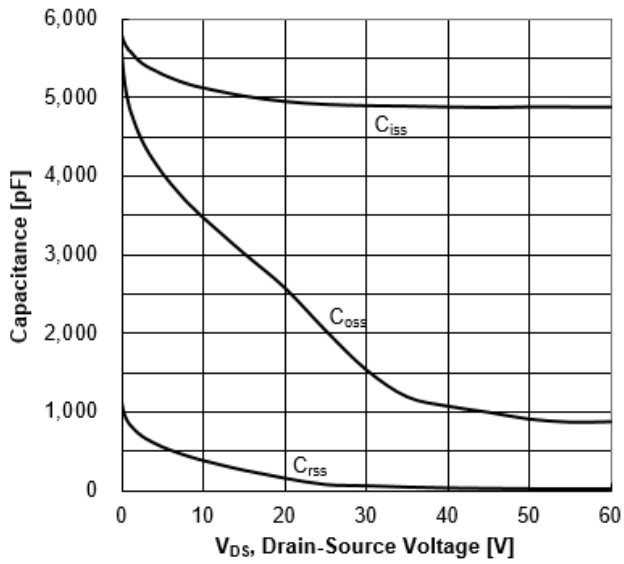
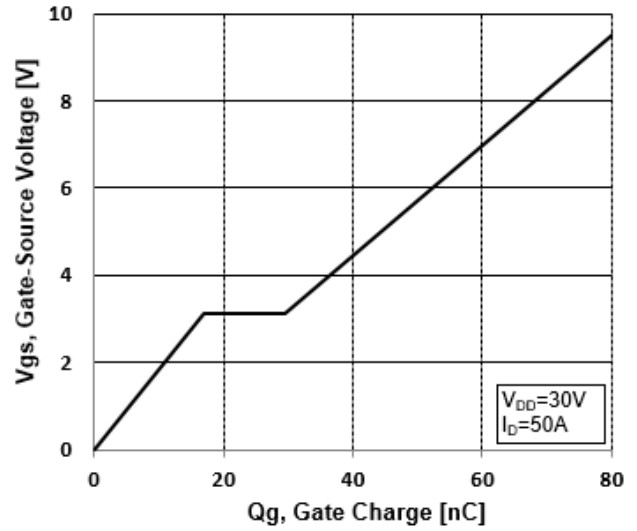


Figure 13. Typical Gate Charge vs Gate-Source Voltage



6. Test Circuit and Waveform

Figure 14. Resistive Switching Test Circuit



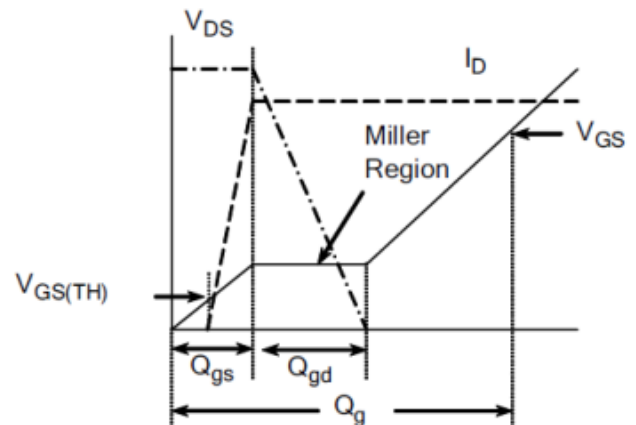
Figure 15. Resistive Switching Waveforms

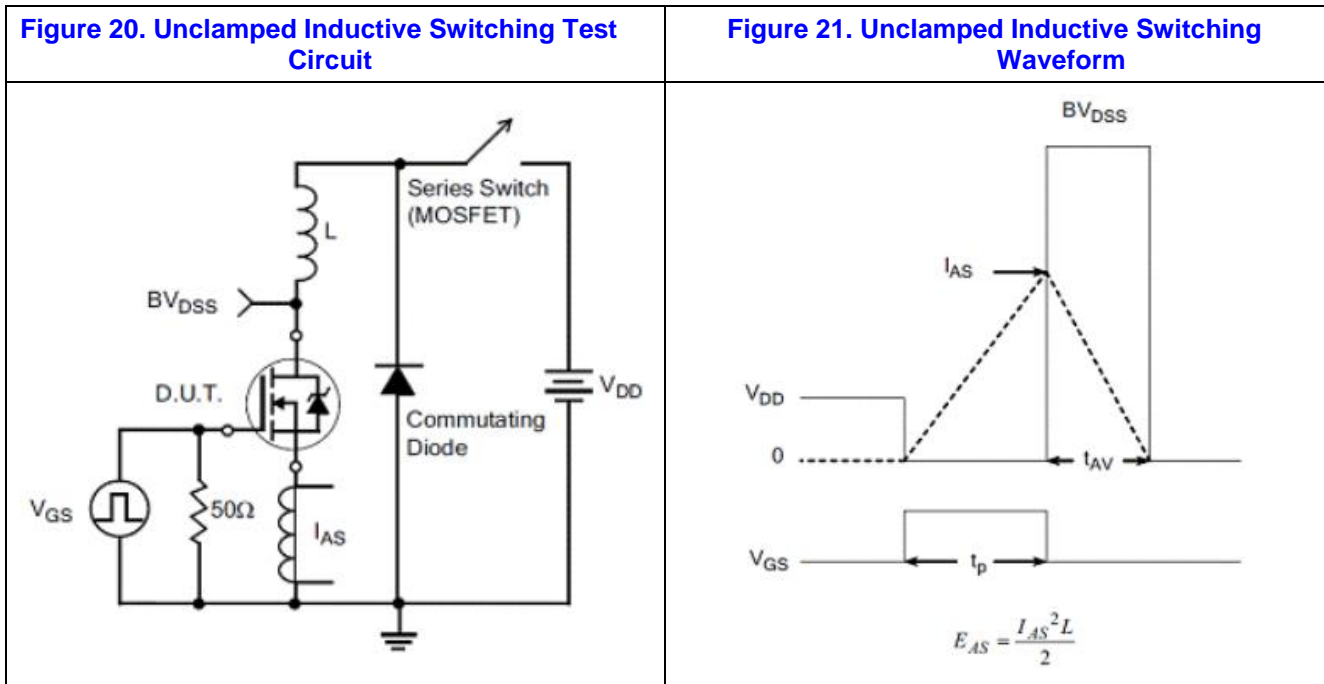
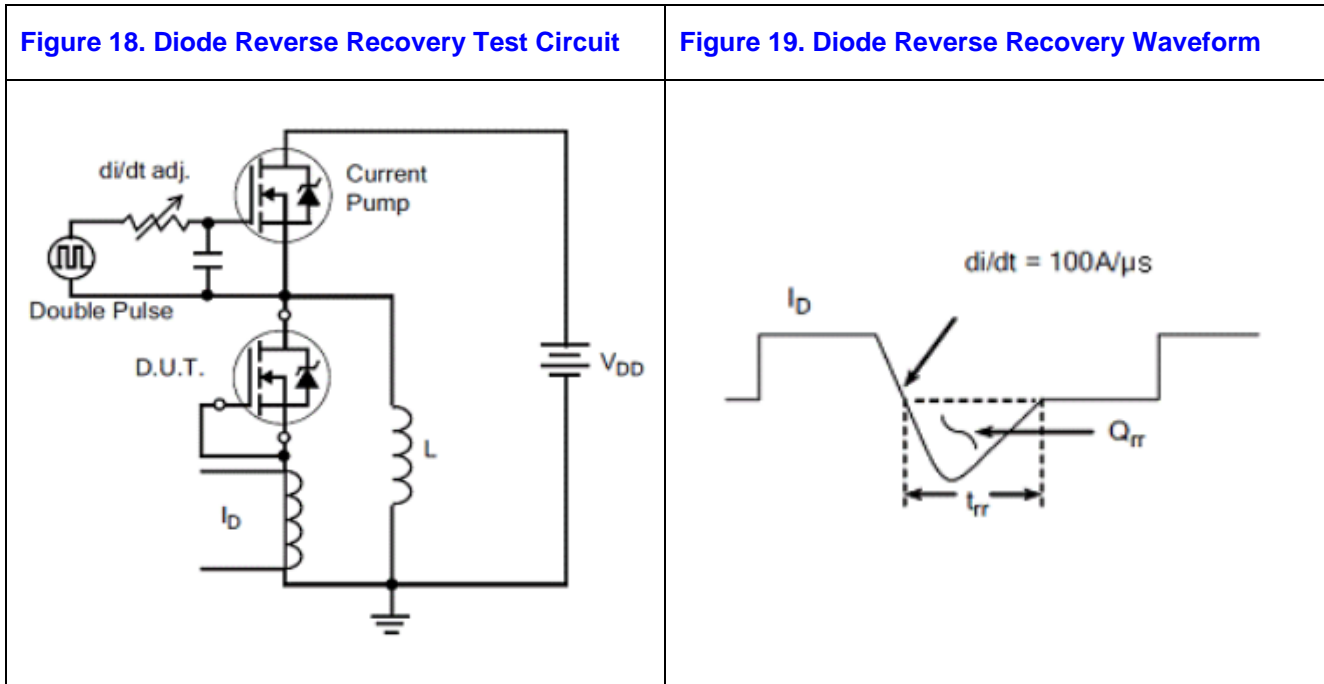


Figure 16. Gate Charge Test Circuit



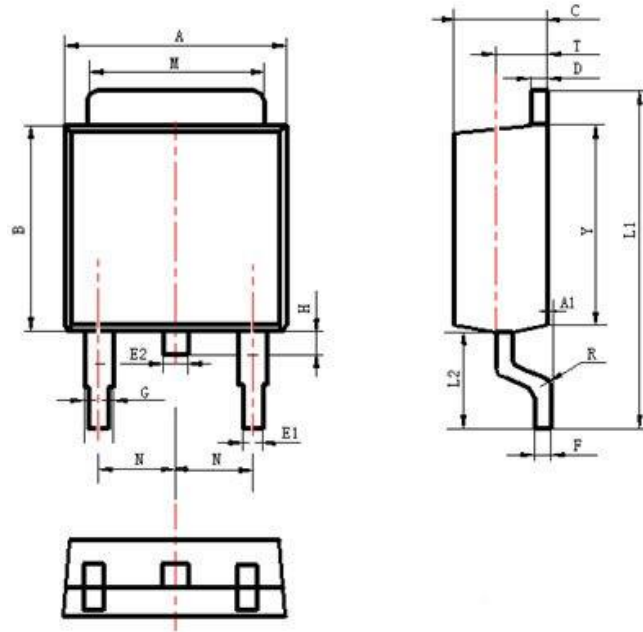
Figure 17. Gate Charge Waveforms





7. Package Description

TO-252



Items	Values(mm)	
	MIN	MAX
A	6.30	6.90
A1	0	0.13
B	5.70	6.30
C	2.10	2.50
D	0.30	0.60
E1	0.60	0.90
E2	0.70	1.00
F	0.30	0.60
G	0.70	1.20
L1	9.60	10.50
L2	2.70	3.10
H	0.60	1.00
M	5.10	5.50
N	2.09	2.49
R	0.3	
T	1.40	1.60
Y	5.10	6.30

NOTE:

1. Exceeding the maximum ratings of the device in performance may cause damage to the device, even the permanent failure, which may affect the dependability of the machine. Please do not exceed the absolute maximum ratings of the device when circuit designing.
2. When installing the heat sink, please pay attention to the torsional moment and the smoothness of the heat sink.
3. MOSFETs is the device which is sensitive to the static electricity, it is necessary to protect the device from being damaged by the static electricity when using it.
4. Shanghai Belling reserves the right to make changes in this specification sheet and is subject to change without prior notice.

CONTACT:

上海贝岭股份有限公司 (总部)

地址: 上海市宜山路 810 号

邮编: 200233

电话: 021-24261000

产品业务咨询及技术支持

电话: 021-24261326

传真: 021-64852222

邮箱: marketing@belling.com.cn

上海贝岭深圳分公司 (华南区)

地址: 深圳市福田区中心区民田路新华保险大厦 1510 室

邮编: 518031

电话: 0755-33336776 0755-33336770

传真: 0755-33336788

上海贝岭北京办事处 (华北区)

地址: 北京市西城区新华里 16 号院锦官苑小区 10 号楼 1 单元 1505 室

邮编: 100044

电话: 010-64179374

传真: 010-8835 9236